

Codice F3133/1

MISCELATORE INCASSO DOCCIA

- solo parte esterna
- **corpo incasso da ordinare separatamente**

IMMAGINE



Vedere le condizioni generali di vendita presenti sul nostro listino in vigore

Finiture

-  CROMO
CR
-  NICKEL SPAZZOLATO
SN
-  CROMO NERO
CN
-  CROMO NERO SPAZZOLATO
CS
-  BIANCO OPACO
BS
-  NERO OPACO
NS
-  ORO
OR
-  ORO SPAZZOLATO
OS
-  BRONZO
BR
-  RAME ANTICO
RA

PRODOTTI DA ORDINARE SEPARATAMENTE

[Corpo da incasso](#)



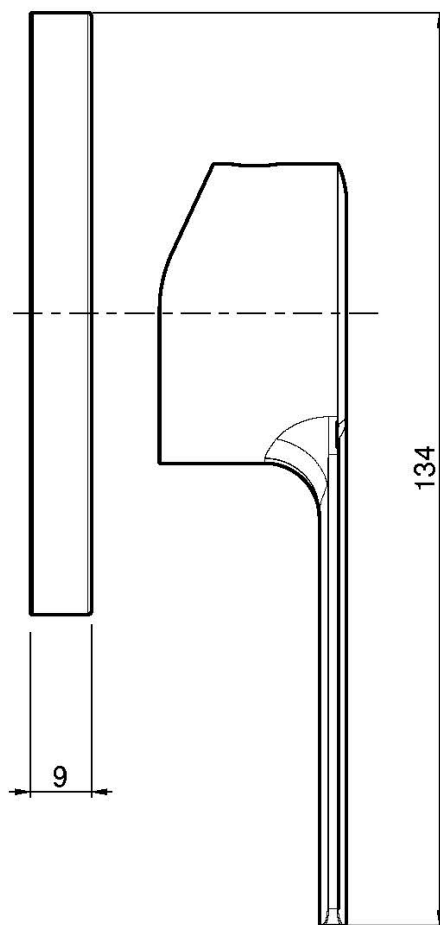
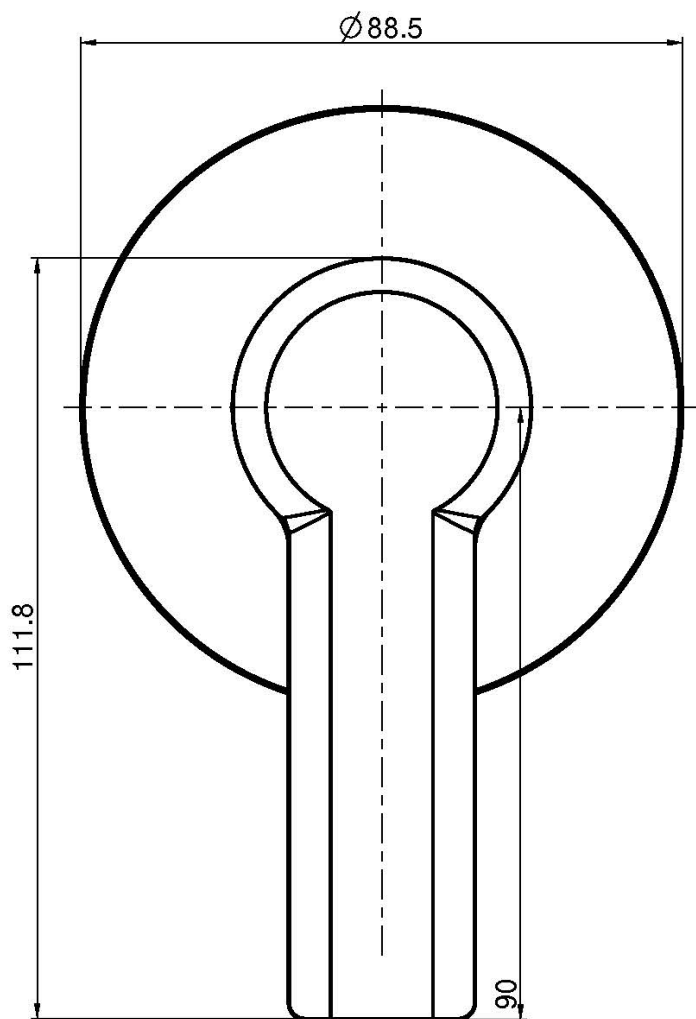

This drawing is the property of FIMA Carlo Frattini. Any complete or partial reproduction, or any transmission to third party without FIMA Carlo Frattini authorization is forbidden.

